

# ercol

## novara upholstery range

---

Thank you for purchasing this novara upholstery. Please read the instructions carefully before use to ensure safe and satisfactory operation of this product

---



---

Please read these instructions carefully before fitting the wooden legs to your new furniture. It is critical that the legs are correctly fitted otherwise serious damage could occur.

---

### Pre-assembly preparation

#### Necessary Tools



---





Please check the pack contents before attempting to assemble this product. A full checklist of components is given in this leaflet. If any components are missing, please contact the retailer from whom you bought this product.

This product is **HEAVY**, it should be assembled as near as possible to the point of use. **TAKE CARE WHEN LIFTING** to avoid personal injury and (or) damage to the product.

The fittings pack contains **SMALL ITEMS** which should be **KEPT AWAY FROM YOUNG CHILDREN.**

Read this leaflet in full before commencing assembly.

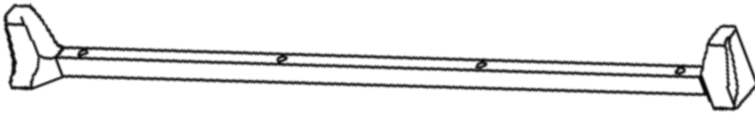
## Fittings and parts checklist

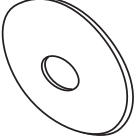
A	Allen key	
B	legs for back of sofas/chairs x 2 legs for footstool x 4	
C	Screw x 2 for all sofas/chairs Screw x 4 for footstool	
D	Front legs x 1	
E	M6 bolts x 5 for all sofas	
F	Cardboard washer x 2 for sofas Cardboard washer x 4 for footstool	

## Step by step assembly instructions

1. Carefully lie the sofa or chair on it's back on a clean soft surface, this is a two person operation.
2. Unscrew the transport legs (by hand) as delivered and discard.
3. Put a cardboard washer on each of the two back feet and screw them in to the threaded inserts underneath the sofas and chairs at the back and all four corners on the footstool.  
When the legs are firmly home and tight as shown in Fig 1. Use a cross head screwdriver, fit the lock screws provided to each leg, and tighten fully. This will prevent the legs from rotating.

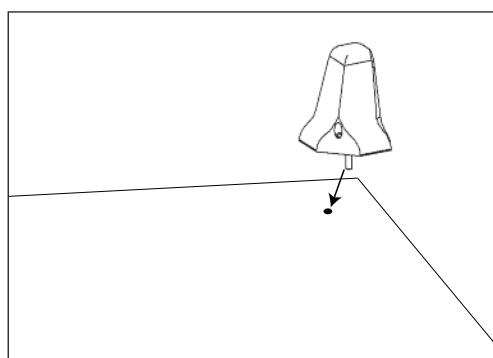
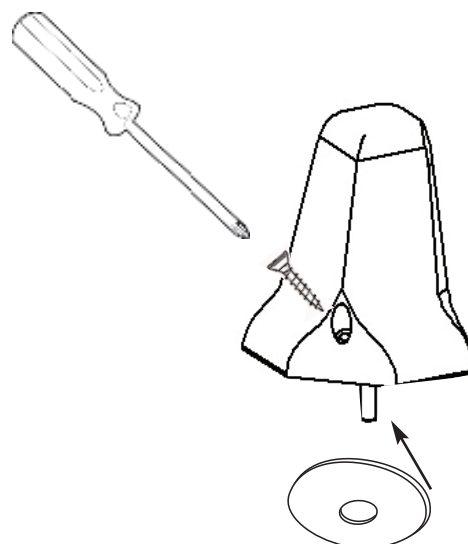

fig.1



4. All sofas are supplied with 5 bolts, not matter what the size. Align the front foot section to the predrilled holes on the underside of the sofa and using the allen key provided bolt the front bar feet to the bottom of the sofa.

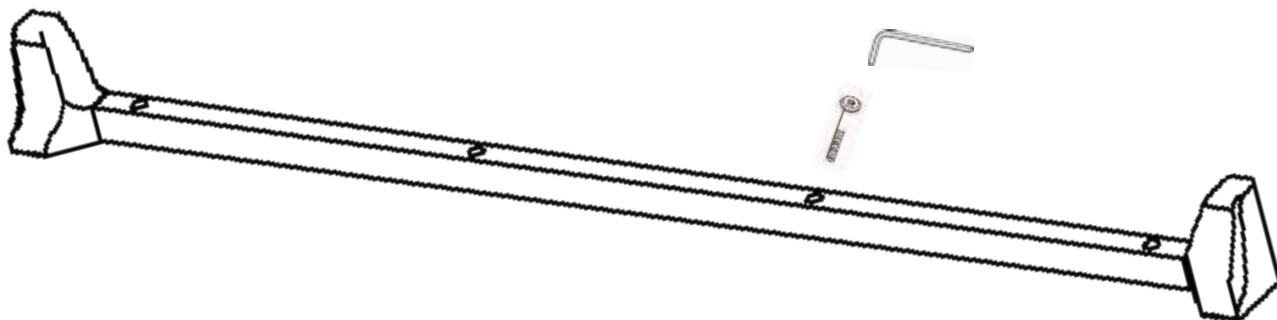

fig.2

5. Once all legs are fitted, the furniture can be carefully lifted upright and positioned as required. Two people are required.

---

## Care and maintenance

---

### Wood Furniture

Wood displays different grain patterns depending on which way it is cut - for example, the 'medullary ray' which can appear on oak furniture is a mark of good quality timber - these are just characteristics of the natural beauty of the wood. Some furniture is also deliberately aged and rustic.

All timber surfaces will change colour and mellow over time. New furniture will initially vary in shade from items that have been previously purchased.

### How to care for your wood furniture

Furniture with a hard lacquer, wax polish or painted surface should be dusted with a dry cloth.

**When using the surface for serving food and drinks it is best to use protective mats and coasters.**

**Spillages should be wiped up as soon as possible.**

Spray polishes are best avoided as they contain silicones which may spoil the furniture's surface by building up over time. **Use of cleaning materials containing abrasive compounds, acidic or caustic reagents and any bleaches containing oxidising reagents should be avoided as prolonged use may damage the lacquer surface.** Wipe up spills immediately. If sticky marks occur on the surface they can be removed with a dilute solution of warm soapy water. **The offending area should be rubbed lightly and then completely dried immediately afterwards, before replacing any mats etc.**

Our furniture will endure most temperatures in the home but it is best to avoid placing furniture next to heat sources such as radiators or fires. Be particularly careful with solid wood as the lack of humidity caused by central heating can cause damage such as warping.

### Safety Instructions

Never drag furniture when moving it, always lift it. Please take care when handling or moving the furniture as careless handling may cause damage or injury. No liability will be accepted for damage or injury caused by incorrectly installed furniture.

**PLEASE KEEP THESE INSTRUCTIONS FOR FUTURE REFERENCE**

Ercol Furniture Ltd, Summerleys Road, Princes Risborough, Bucks. HP27 9PX [www.ercol.com](http://www.ercol.com)